

EPSON

Color Ink Jet Printer

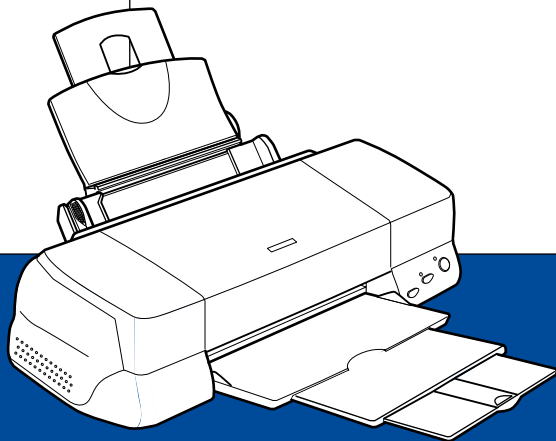

EPSON STYLUS™ PHOTO 1290

Daily Use

4032768-00
EUL

Where to Find Information

Setup Guide

This guide will help you set up and begin using your printer. It includes information on setting up your printer and installing the printer software.

Photo Print Software Setup included on the CD-ROM

This guide provides information on installing EPSON PhotoQuicker, EPSON PhotoStarter and EPSON CardMonitor. It also contains uninstalling and system requirements.

Daily Use guide

This guide provides information on normal printer operation. It also contains troubleshooting tips and customer support information.

PhotoQuicker User's Guide

Included on the printer software CD-ROM, this guide provides basic information on using the EPSON PhotoQuicker utility to print your photo data. It also contains troubleshooting tips.

Reference Guide included on the CD-ROM

The Reference Guide contained on the CD-ROM included with your printer provides detailed information about printer software settings, printing on special paper, maintenance, and problem solving.

To open the *Reference Guide*, insert the printer software CD in the CD-ROM drive.

For Windows, select Online Guide in the Installer dialog box and click . Then, click View Reference Guide to open the guide.

For Macintosh, double-click the Online Guide icon in the EPSON window and then the Online Guide icon. Then, click View Reference Guide to open the guide.

Note:

It is possible to install the Reference Guide on your hard disk. See "For Windows" or "For Macintosh" in your Setup Guide for instructions.

All rights reserved. No part of this publication may be reproduced, stored in a retrieval system, or transmitted in any form or by any means, electronic, mechanical, photocopying, recording, or otherwise, without the prior written permission of SEIKO EPSON CORPORATION. The information contained herein is designed only for use with this EPSON printer. EPSON is not responsible for any use of this information as applied to other printers.

Neither SEIKO EPSON CORPORATION nor its affiliates shall be liable to the purchaser of this product or third parties for damages, losses, costs, or expenses incurred by the purchaser or third parties as a result of accident, misuse, or abuse of this product or unauthorized modifications, repairs, or alterations to this product, or (excluding the U.S.) failure to strictly comply with SEIKO EPSON CORPORATION's operating and maintenance instructions.

SEIKO EPSON CORPORATION shall not be liable for any damages or problems arising from the use of any options or any consumable products other than those designated as Original EPSON Products or EPSON Approved Products by SEIKO EPSON CORPORATION.

SEIKO EPSON CORPORATION shall not be held liable for any damage resulting from electromagnetic interference that occurs from the use of any interface cables other than those designated as EPSON Approved Products by SEIKO EPSON CORPORATION.

EPSON is a registered trademark and EPSON Stylus is a trademark of SEIKO EPSON CORPORATION.

Copyright 2001 SEIKO EPSON CORPORATION. All rights reserved. PRINT Image Matching is a trademark of SEIKO EPSON CORPORATION. The PRINT Image Matching logo is a trademark of SEIKO EPSON CORPORATION.

Microsoft and Windows are registered trademarks of Microsoft Corporation.

Apple and Macintosh are registered trademarks of Apple Computer, Inc.

DPOF is a trademark of CANON INC., Eastman Kodak Company, Fuji Photo Film Co., Ltd. and Matsushita Electric Industrial Co., Ltd.

***General Notice:** Other product names used herein are for identification purposes only and may be trademarks of their respective owners. EPSON disclaims any and all rights in those marks.*

Copyright © 2002 by SEIKO EPSON CORPORATION, Nagano, Japan.



Printed on Recycled Paper.

Contents

| | |
|--|-----------|
| Safety Instructions | 1 |
| Important Safety Instructions | 1 |
| Information for United Kingdom Users | 5 |
| Warnings, Cautions, and Notes | 7 |
| Printer Parts and Control Panel Functions | 8 |
| Printer Parts | 8 |
| Buttons | 9 |
| Lights | 10 |
| Loading Paper | 11 |
| Loading Special Paper and Other Media | 11 |
| Loading Envelopes | 14 |
| Using Roll Paper | 16 |
| Using the Roll Paper Holder | 16 |
| Removing the Roll Paper from the Printer | 20 |
| Printing with Windows | 22 |
| Printer Software Introduction | 22 |
| Making Settings on the Main Menu | 23 |
| Making Settings on the Paper Menu | 24 |
| Making Settings on the Layout Menu | 25 |
| Printing with Macintosh | 26 |
| Printer Software Introduction | 26 |
| Making settings in the Print dialog box | 27 |
| Making settings in the Page Setup dialog box | 28 |
| Making settings in the Layout dialog box | 29 |
| Replacing Ink Cartridges | 30 |

Using the Printer's Control Panel 30

Troubleshooting 35

Error Indicators 37

Maintenance 39

Correcting USB Problems 41

Options and Consumable Products 47

Options 47

Consumable products 48

Customer Support 54

Technical Support Web Site 54

Contacting Customer Support 54

System Requirements 67

Using the online Reference Guide 67

Safety Instructions

Important Safety Instructions

Read all of the instructions in this section before using your printer. Also, be sure to follow all warnings and instructions marked on the printer.

When setting up your printer

Observe the following when setting up the printer:

- Do not block or cover the openings in the printer's cabinet.
- Use only the type of power source indicated on the printer's label.
- Connect all equipment to properly grounded power outlets. Avoid using outlets on the same circuit as photocopiers or air control systems that regularly switch on and off.
- Avoid electrical outlets controlled by wall switches or automatic timers.
- Keep the entire computer system away from potential sources of electromagnetic interference, such as loudspeakers or the base units of cordless telephones.
- Do not use a damaged or frayed power cord.

- ❑ If you use an extension cord with the printer, make sure that the total ampere rating of the devices plugged into the extension cord does not exceed the cord's ampere rating. Also, make sure that the total ampere rating of all devices plugged into the wall outlet does not exceed the wall outlet's ampere rating.
- ❑ Do not attempt to service the printer yourself.
- ❑ Unplug the printer and refer servicing to qualified service personnel under the following conditions:

The power cord or plug is damaged; liquid has entered the printer; the printer has been dropped or the cabinet damaged; the printer does not operate normally or exhibits a distinct change in performance.
- ❑ If you plan to use the printer in Germany, the building installation must be protected by a 10 or 16 amp circuit breaker to provide adequate short-circuit protection and over-current protection for this printer.

When choosing a place for the printer



Observe the following when choosing a place for the printer:

- ❑ Place the printer on a flat, stable surface that extends beyond the printer base in all directions. The printer will not operate properly if it is tilted or at an angle.
- ❑ Leave enough space in front of the printer for the paper to be fully ejected.
- ❑ Avoid places subject to rapid changes in temperature and humidity. Also, keep the printer away from direct sunlight, strong light, or heat sources.
- ❑ Avoid places subject to dust, shocks, and vibrations.

- ❑ Leave enough room around the printer to allow for sufficient ventilation.
- ❑ Place the printer near a wall outlet where the plug can be easily unplugged.

When using the printer

Observe the following when using the printer:

- ❑ Do not insert objects through the slots in the printer's cabinet.
- ❑ Take care not to spill liquid on the printer.
- ❑ Do not put your hand inside the printer or touch the ink cartridges during printing.
- ❑ Do not move the print head by hand; otherwise, you may damage the printer.
- ❑ Always turn the printer off using the  power button. When this button is pressed, the  power light flashes briefly and then goes out. Do not unplug the printer or turn off the power to the outlet until the  power light stops flashing.
- ❑ Before transporting the printer, make sure that the print head is in the home (far right) position and the ink cartridges are in place.

When handling the ink cartridges

Observe the following when handling the ink cartridges:

- ❑ Keep ink cartridges out of the reach of children. Do not allow children to drink from or otherwise handle the cartridges.

- ❑ Be careful when you handle the used ink cartridges, as there may be some ink remaining around the ink supply port. If ink gets on your skin, wash the area thoroughly with soap and water. If discomfort or vision problems remain after a thorough flushing, see a doctor immediately.
- ❑ Do not shake an ink cartridge; this can cause leakage.
- ❑ Install the ink cartridge immediately after you remove it from its package. Leaving the cartridge unpacked for a long time before use may result in reduced print quality.
- ❑ Do not use an ink cartridge beyond the date printed on the cartridge carton. For best results, use up the ink cartridges within six months of installing them.
- ❑ Do not dismantle the ink cartridges or try to refill them. This could damage the print head.
- ❑ After bringing an ink cartridge inside from a cold storage site, allow it to warm up at room temperature for at least three hours before using it.
- ❑ Store ink cartridges in a cool, dark place.
- ❑ Do not touch the green IC chip on the side of the cartridge. This may affect normal operation and printing.
- ❑ The IC chip on this ink cartridge retains a variety of cartridge related-information, such as the amount of ink remaining, so that a cartridge may be removed and reinserted freely. However, each time the cartridge is inserted, some ink is consumed because the printer automatically performs a reliability check.

- ❑ If you remove an ink cartridge for later use, protect the ink supply area from dirt and dust and store it in the same environment as the printer. A valve in the ink supply port makes covers or plugs unnecessary, but the ink may stain items that come in contact with this area of the cartridge. Do not touch the ink supply port or surrounding area.

ENERGY STAR® Compliance

As an ENERGY STAR® Partner, EPSON has determined that this product meets the ENERGY STAR® guidelines for energy efficiency.

The International ENERGY STAR® Office Equipment Program is a voluntary partnership with the computer and office equipment industry to promote the introduction of energy-efficient personal computers, monitors, printers, fax machines, copiers, and scanners in an effort to reduce air pollution caused by power generation.

Information for United Kingdom Users

Use of options

EPSON (UK) Limited shall not be liable against any damages or problems arising from the use of any options or consumable products other than those designated as Original EPSON Products or EPSON Approved Products by EPSON (UK) Limited.

Safety information



Warning:

This appliance must be earthed. Refer to the rating plate for the voltage and check that the appliance voltage corresponds to the supply voltage.

Important: *The wires in the mains lead fitted to this appliance are coloured in accordance with the following code:*

Green and yellow — Earth

Blue — Neutral

Brown — Live

If you have to fit a plug:

As the colours of the mains lead of this appliance may not match the coloured markings used to identify the terminals in a plug, please observe the following:

- The green and yellow wire must be connected to the terminal in the plug which is marked with the letter E or the earth symbol (\perp).
- The blue wire must be connected to the terminal in the plug marked with the letter N.
- The brown wire must be connected to the terminal in the plug marked with the letter L.
- If the plug is damaged, replace the cord set or consult a qualified electrician.
- Replace fuses only with fuses of the correct size and rating.

Warnings, Cautions, and Notes



Warnings must be followed carefully to avoid bodily injury.



Cautions must be observed to avoid damage to your equipment.

Notes contain important information and useful tips on the operation of your printer.



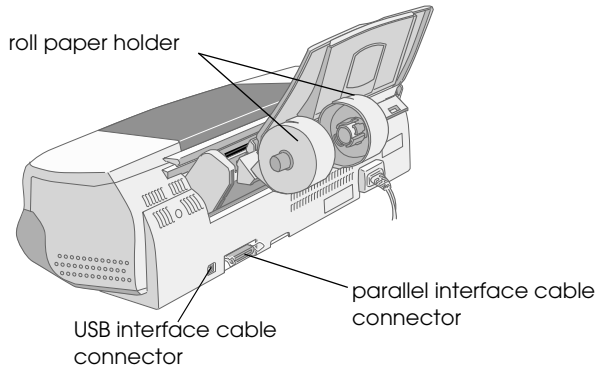
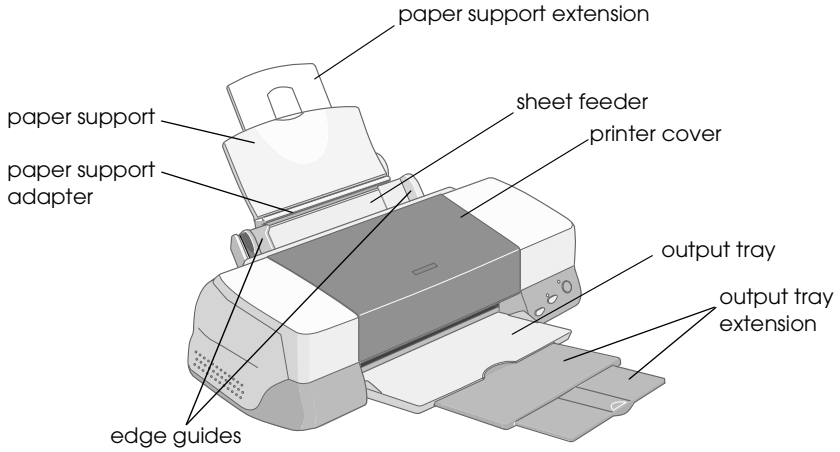

Printer Parts and Control Panel Functions

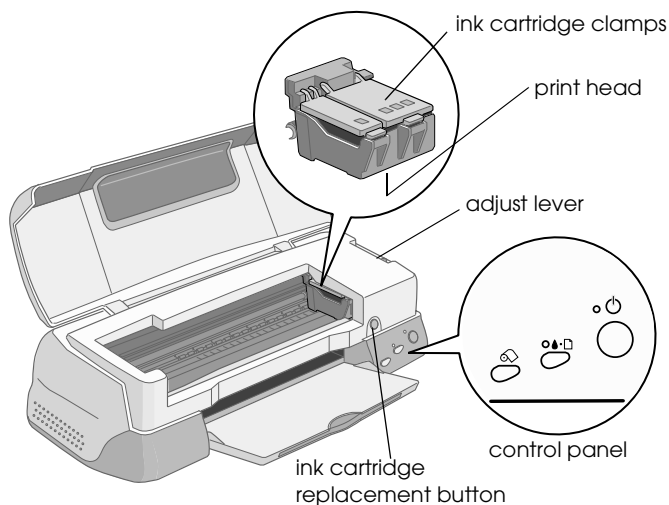
Printer Parts







Buttons

| Button | Function |
|---|--|
|  power | Turns the printer on and off. Clears the printer's memory if pressed twice while the power is on. |
|  maintenane | Loads or ejects paper if pressed and released within two seconds. Resumes printing if pressed and released after a paper out error. Performs print head cleaning if pressed for 3 seconds when the  error light is off. Moves the print head to the ink cartridge replacement position and charges ink to the printer when ink is out. |
|  roll paper | Loads and ejects roll paper. Feeds roll paper in reverse to a position where it can be easily removed from the sheet feeder, if pressed for more than 3 seconds. Clears the  error light if pressed after removing roll paper. |

| | |
|--|--|
|  ink cartridge replacement | Moves the print head to the ink cartridge replacement position and charges ink to the printer when ink is out (this orange button is located under the printer cover, not in the control panel). |
|--|--|

Lights

| Light | Description |
|--|---|
|  power | <p>On when the printer is on.</p> <p>Flashing when printer is receiving data, printing, replacing an ink cartridge, charging ink, or cleaning the print head.</p> |
|  error | <p>On when the printer is out of paper. Load paper in the sheet feeder, then press the  maintenance button to resume printing.</p> <p>On when the paper is jammed. Take all of the paper out of the feeder, then reload the paper. If the light continues to flash, turn off the printer and gently pull all of the paper out of the printer.</p> <p>Flashing when the black or color ink cartridge is nearly empty.</p> <p>On when the black or color ink cartridge is empty. Replace the black ink cartridge or color ink cartridge.</p> <p>Black: T007 Standard Capacity T010 Light Capacity Color: T009 (Stylus Photo 1290)</p> <p>Flashing when the print head moves to the ink cartridge replacement position. If the color ink is out the light will flash faster than if the black ink is out.</p> |

Loading Paper

Loading Special Paper and Other Media

You can print on a wide variety of special media, including ink jet paper, photo quality glossy film, photo paper, transparencies, index cards, and adhesive sheets.

Loading instructions

When loading special media distributed by EPSON, read the instruction sheets packed with the media first and keep the following points in mind.



Caution:

Cleaning sheets packaged with EPSON special media should not be used with this printer. The cleaning function performed by these sheets is not necessary with this type of printer, and the sheets could jam in the printer.

Note:

For more details on using special media, see “Paper Handling” in the online Reference Guide.

- ❑ Load the media printable side up in the sheet feeder. See the instruction sheets packed with the media to determine which side is the printable side. Some types of media have cut corners to help identify the correct loading direction, as shown in the illustration.

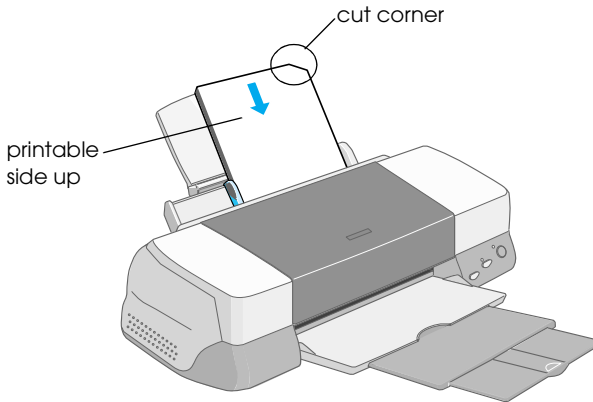

- ❑ Make sure that the paper stack fits under the arrow mark located on the inside surface of the left edge guide.

Loading capacities for EPSON special media

Refer to the chart below to find the loading capacities for EPSON special media.

| Media Type | Loading Capacity |
|---|---|
| 360 dpi Ink Jet Paper and Photo Quality Ink Jet Paper | Up to the arrow mark on the left edge guide. |
| Photo Quality Ink Jet Cards, Ink Jet Note Cards, and Ink Jet Greeting Cards | Up to 30 index cards. Always place the included support sheet* under the cards. |
| Photo Quality Glossy Film | One sheet at a time for best results. Always place a support sheet* or a sheet of plain paper under the glossy film. If you wish to load multiple sheets, set the minimum top margin of the page to 30 mm and load a maximum of 20 sheets for A4. For A3 and Super A3 size, you can load up to 5 sheets at a time. |
| Ink Jet Transparencies | Up to 30 transparencies. Always put a sheet of plain paper under the stack of transparencies. |
| Photo Quality Self Adhesive Sheets | One sheet at a time. |
| Photo Paper | Up to 20 sheets of 4 × 6 inch Photo Paper. Always place a support sheet* under the stack of Photo Paper. One sheet at a time for 200 × 300 mm Photo Paper. |
| Photo Stickers 16 and Photo Stickers 4 | One sheet at a time. Always put the included support sheets* A and B under the stack of Photo Stickers. |
| Panoramic Photo Paper and Iron-On Cool Peel Transfer Paper | One sheet at a time. |

| | |
|----------------------------|---|
| Matte Paper-Heavyweight | Up to 20 sheets. Always place a support sheet* under the stack of Matte Paper-Heavyweight. For A3 and Super A3 size, you can only load one sheet at a time. |
| Premium Glossy Photo Paper | One sheet at a time. |
| Ink Jet Back Light Film | One sheet at a time. Always put a sheet of plain paper under back light film. |
| ColorLife Photo Paper | One sheet at a time |

* Take care not to print on support sheets that are loaded under special media.

Loading Envelopes

When printing on envelopes, please note the following:

- You can load up to 10 envelopes at a time in the sheet feeder.

Note:

The folding quality and thickness of envelopes vary widely. If the total thickness of the stack of envelopes exceeds 10 mm, press each envelope in the stack flat before loading. If print quality declines when a stack of envelopes is loaded, load one envelope at a time.

- Set the adjust lever to the “+” position. To do this, open the printer cover and reposition the lever.

Note:

- Return the adjust lever to the “0” position, which is the normal position, after you finish printing on envelopes. Leaving the lever in the “+” position may cause gaps to appear in images printed on other media.*

- When the adjust lever is in the “+” position, make sure the High Speed setting in the printer driver’s Advanced dialog box is off. To turn this option off, you may also need to change the Print Quality setting.*

- ❑ Load envelopes flap edge first with the flap side down, as shown in the illustration.

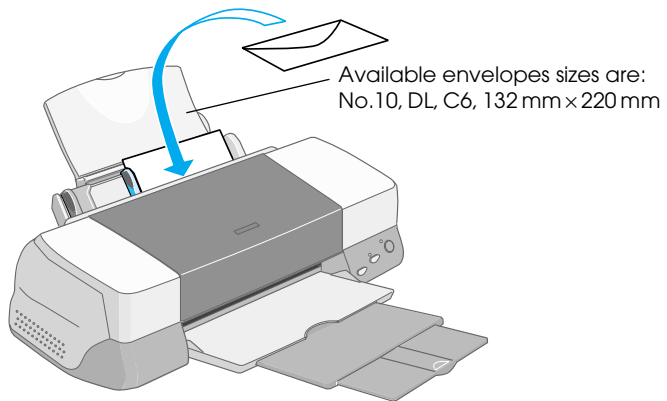

- ❑ Do not use envelopes that are curled or folded.
- ❑ Flatten envelopes before loading.
- ❑ Avoid using envelopes that are too thin as they may curl during printing.
- ❑ Select Plain Paper as the Media Type setting in the printer software.

Using Roll Paper

Using the Roll Paper Holder

With the Roll paper holder packed with the printer, you can print in roll paper format which is convenient for banner printing. When you are printing using the Roll paper holder, keep the following in mind.

- ❑ Load the paper printable side up.
- ❑ Use flat, undamaged paper. If the paper is curled, flatten it before loading to avoid paper feeding problems.
- ❑ Always handle the paper by the edges.
- ❑ Provide ample space in front of the printer for the paper to eject fully.
- ❑ Make sure that the output tray is down and the output tray extension is closed.
- ❑ Check that the end of the paper is cut cleanly, perpendicular to the long axis of the paper. If it is cut on a diagonal or not cleanly, the paper may not feed smoothly or the print may extend off the edge of the paper.
- ❑ EPSON recommends using media distributed by EPSON to ensure high-quality results.

Loading the Roll Paper

Follow the directions below to mount the Roll paper holder and load the roll paper.

1. Set roll paper in the roll paper holder.

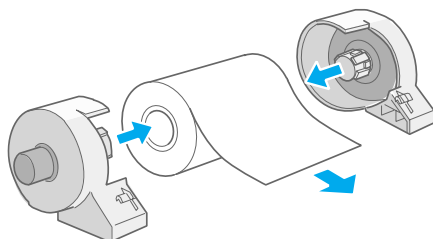

Note:

Remove the transparent sheet after setting the roll paper into the holders.

2. Check that the end of the roll is cut perpendicularly to the edges as shown. For A4 and 329-mm width paper, cut along one of the parallel lines on the back. For 89- and 100-mm width paper, use a triangle.

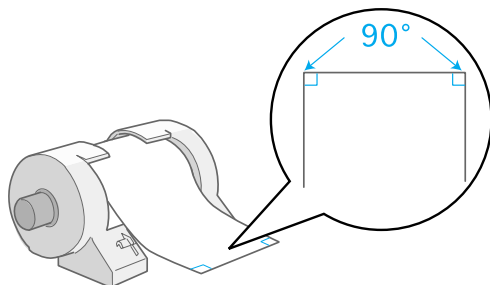

Caution:

Always use a triangle or other tool to ensure that the end of the roll is cut perpendicularly. A diagonal cut may cause paper feed problems.

3. To uncurl the paper, roll the paper inside the protective film packaged with the printer in the direction opposite to the paper's curl, as shown below.

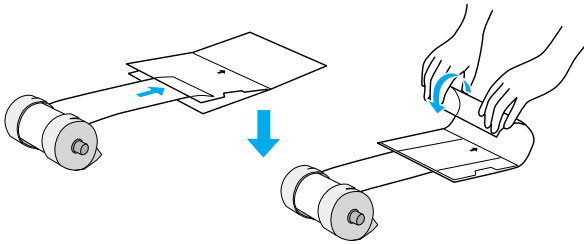

4. Remove the paper support and lower the output tray. Then, turn on the printer.

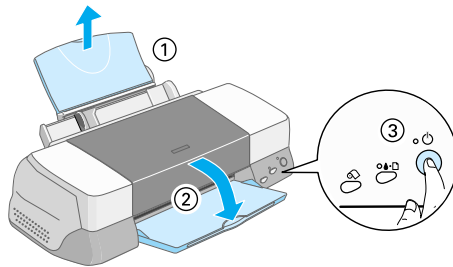

5. Attach the roll paper holder to the printer. Adjust the first left of slot in the back of printer and insert roll paper holder into slots.

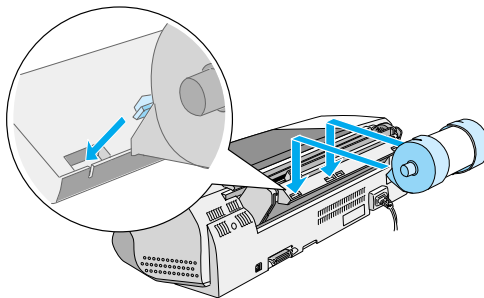

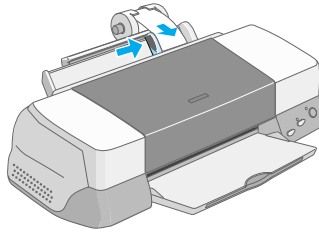

6. Gently insert the end of the paper into the printer as far as it will go, flush with the right edge guide. Slide the left edge guide against the left edge of the paper.

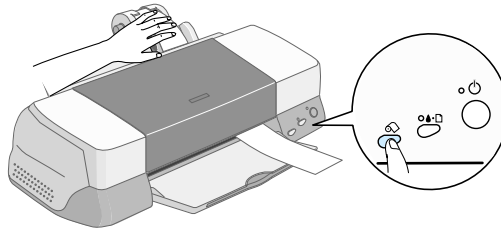

7. To load the paper correctly, you must hold the paper in place with your hand while you press the  roll paper button. The paper feeds into the printer.



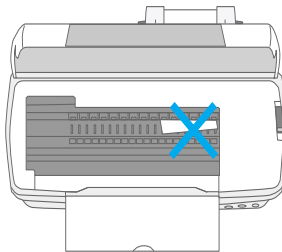

8. Open the printer cover and make sure that the paper is feeding correctly. If it is not straight, depress the  roll paper button for more than three seconds to eject the paper. The error light is on. Press the  roll paper button to clear the error, then feed the paper again.



The roll paper is now loaded. Next, set up the printer software and try printing. For details on setting up the printer software, refer to “Printing on Roll Paper” in the online *Reference Guide*.



Removing the Roll Paper from the Printer

After the print job is complete, press the  roll paper button; a line is printed on the roll paper indicating where to cut the paper. Follow the directions below to remove the paper from the printer.

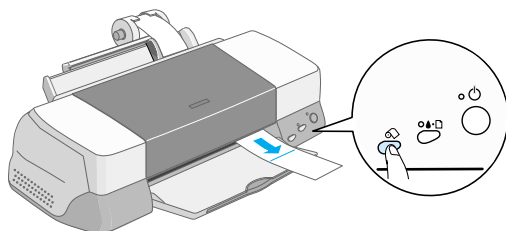
1. Press the  roll paper button to feed the paper. This time, a cutting guide line is printed.



Note:

- ❑ *If you want to print more data on the same sheet of paper, press the  roll paper button and send the next print job. The paper will return to the printing start position before starting the next print job.*
 - ❑ *You must press the  roll paper button; otherwise, the printer will not operate even if you send a new print job. However, do not press the  roll paper button more than is necessary; repeated motion may damage the printout.*
2. Cut the paper along the printed line. Never pull the paper as you cut it. Doing so may damage the printout. When cutting the paper, do not cut inside the line (closer to the printer) as this may cause paper feed problems.

Note:

EPSON recommends that you use a triangle or other tool to ensure that the end of the roll is cut perpendicularly. A diagonal cut may cause paper feed problems.

3. Once you have cut the paper, hold down the  roll paper button for about 3 seconds. The paper feeds in reverse to a position where it can be easily removed from the sheet feeder at the back of the printer. If it does not feed to this position, repeat this step.

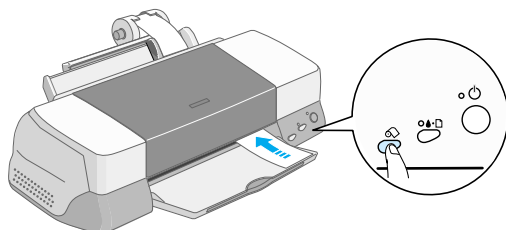

4. Gently remove the paper. Then, press the  roll paper button to clear the error light.

Your document has now been printed.

Printing with Windows

Printer Software Introduction

The printer software which comes with your printer includes a printer driver and printer utilities. The printer driver lets you choose from a wide variety of settings to get the best results from your printer. The printer utilities help you check the printer and keep it in top operating condition.

Accessing the printer software

After you open your application program and create your document, you are ready to select your printer software settings. From the File menu, click Print. You see your application's Print dialog box.

Make sure your printer is selected in the dialog box. Once you click Properties, Printer, Setup or Options (Depending on your application, you may need to click a combination of these buttons.), you see your printer software dialog box.

Note:

You can get specific help related to any item on a menu by right-clicking the item and then clicking the What's This? command.

Making Settings on the Main Menu

You can make Media Type, Mode, Ink, and Print Preview settings on the Main menu.

Note:

You should always make the Media Type setting first, as this setting determines what other settings are available.

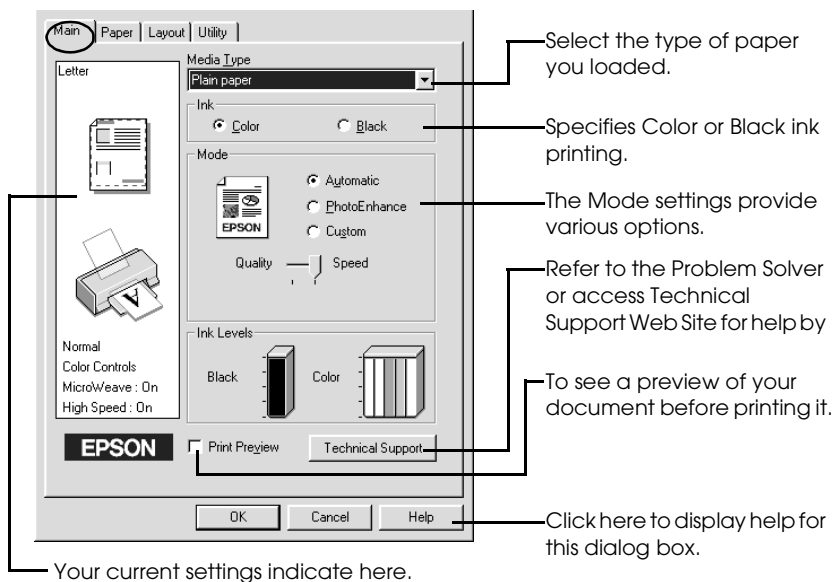

For more information about the Main menus, see your online *Reference Guide*.

Note:

For the latest information on available media, visit our regional customer service web site. See "Contacting Customer Support" on page 54.

Making Settings on the Paper Menu

Use the settings on the Paper menu to change the paper size, set the number of copies and other copy parameters, specify the paper orientation, and adjust the printable area.

The settings which are available vary depending upon whether the sheet feeder or the roll paper is selected as the Paper Source setting.

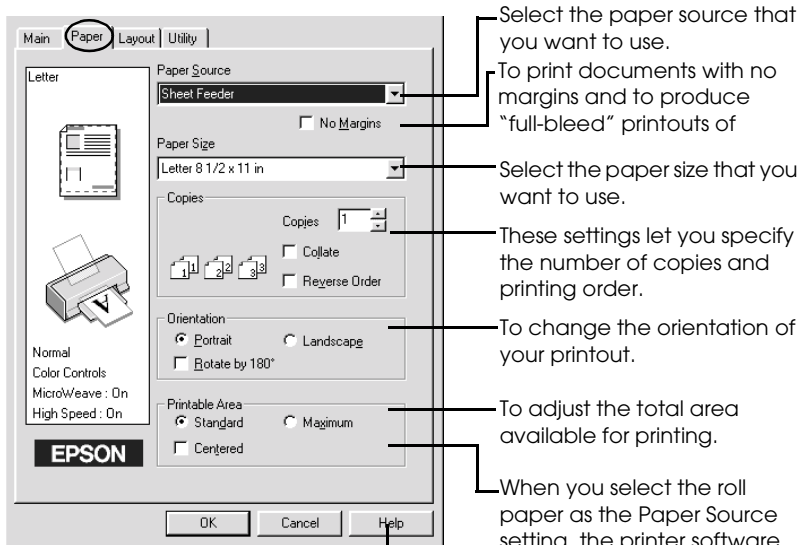

Click here to display help for this dialog box.

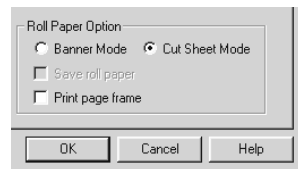

For more information about the Paper menus and the Roll Paper settings, see your online *Reference Guide*.

Making Settings on the Layout Menu

You can make Reduce/Enlarge, Double-Sided Printing, Multi-Page, and Watermark settings on the Layout menu.

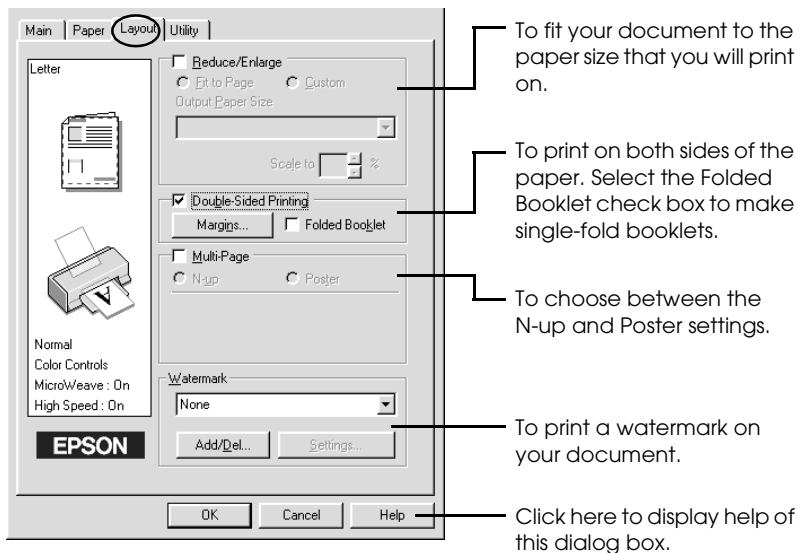

For more information about the Layout menus, see your online *Reference Guide*.

Printing with Macintosh

Printer Software Introduction

The printer software which comes with your printer includes a printer driver and printer utilities. The printer driver lets you choose from a wide variety of settings to get the best results from your printer. The printer utilities help you check the printer and keep it in top operating condition.

For information on using the printer utilities, see “Using the Printer Utilities” in the online *Reference Guide*.

You can also get more information about the printer software by clicking the help icon in any of the dialog boxes in the printer software.

If you encounter any problems when using the printer software, refer to the EPSON Technical Support Web Site. To access the web site from the printer software CD-ROM, insert the CD in the CD-ROM drive and open the Install Printer Driver/Utility folder in the EPSON folder, and then double-click the Technical Support Web Site icon.

Making settings in the Print dialog box



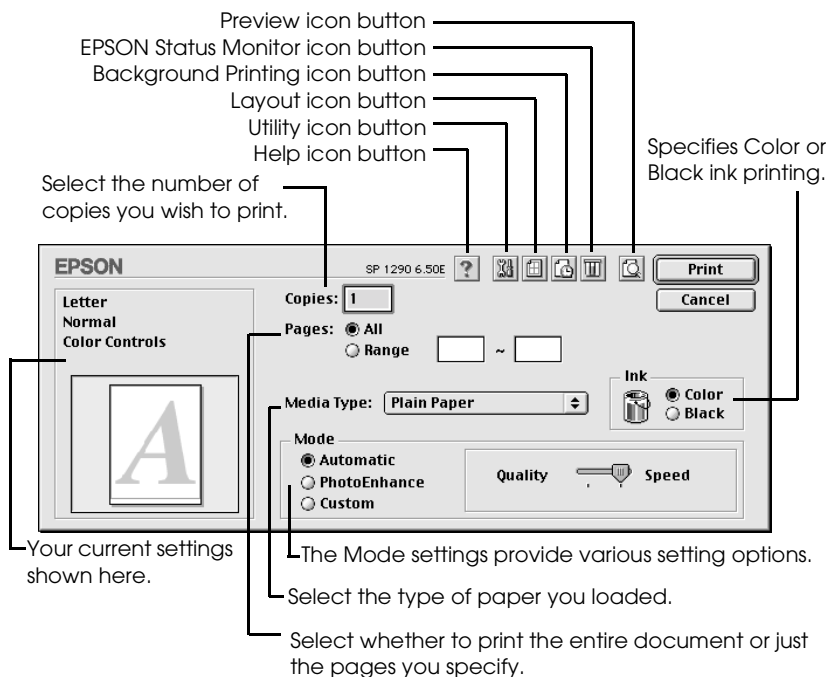

You can make Media Type, Mode, Ink, Copies, and Pages settings in the Print dialog box. From this dialog box, you can also access other dialog boxes, from which you can set the print time, preview the document before printing, and save spool data as a file.

Note:

You should always make the Media Type setting first, as this setting determines what other settings are available.



Note:

- ❑ Use the  Preview icon button to toggle between the  Print,  Preview, and  Save File modes. Click the icon to select the mode that you want. For details, see your online Reference Guide.
- ❑ For the latest information on available media, visit our regional customer service web site. See "Contacting Customer Support" on page 54.

Making settings in the Page Setup dialog box

In the Page Setup dialog box, you can change the paper size, specify the paper orientation, print on both sides of the paper, rotate your document by 180 degrees, reduce or enlarge your printout, and adjust the printable area.

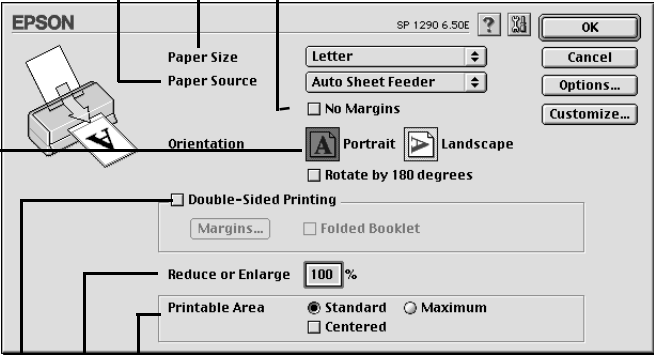

The screenshot shows the EPSON Page Setup dialog box with the following settings and callouts:

- Paper Size:** Letter (dropdown menu)
- Paper Source:** Auto Sheet Feeder (dropdown menu)
- Orientation:** Portrait (selected), Landscape (unselected)
- Rotate by 180 degrees:** (checkbox, unselected)
- No Margins:** (checkbox, unselected)
- Double-Sided Printing:** (checkbox, unselected)
- Margins...:** (button)
- Folded Booklet:** (checkbox, unselected)
- Reduce or Enlarge:** 100% (text box)
- Printable Area:** Standard (selected), Maximum (unselected), Centered (checkbox, unselected)

Callout lines point to the following text:

- Select the paper source that you want to use.
- Select the paper size that you want to use.
- To print document with no margins and to produce "full-bleed" printouts of image.
- To adjust the total area available for printing.
- When you select the roll paper as the Paper Source setting, the printer software will appear as shown below.
- You can reduce or enlarge your document.
- To print on both sides of the paper.
- To change the orientation of your printout.

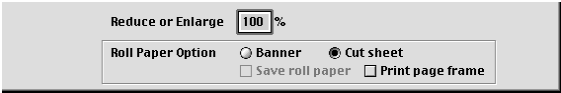

Reduce or Enlarge 100%

Roll Paper Option

- Banner
- Cut sheet
- Save roll paper
- Print page frame

For more information about the Page Setup dialog box and the Roll Paper settings, see your online *Reference Guide*.

Making settings in the Layout dialog box

You can modify the page layout of your document using the printer driver settings located in the Layout dialog box. To open this dialog box, click Print on the File menu of your application, then click the  Layout icon button in the Print dialog box.

Automatically adjusts the size of your document to match the paper size used by your printer.

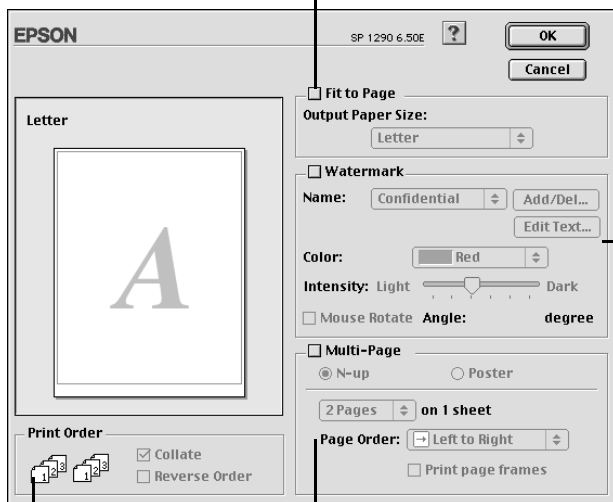

Specify the printing order for your print job.

To choose between the N-up and Poster settings.

Prints a watermark in the background of your document.

For more information about the Layout dialog box, see your online *Reference Guide*.

Replacing Ink Cartridges

Using the Printer's Control Panel

This printer uses ink cartridges equipped with IC chips. The IC chip accurately monitors the amount of ink used by each cartridge, so even if a cartridge is removed and later inserted again, all of its ink can be used. However, some ink is consumed each time the cartridge is inserted because the printer automatically checks reliability.

You can replace an ink cartridge using the printer's control panel or using the Status Monitor utility. To replace an ink cartridge using the  ink cartridge replacement button on the printer's control panel, follow the steps below. To replace an ink cartridge or check ink levels using the Status Monitor utility, refer to "Using the Status Monitor" in the online *Reference Guide*.



Warning:

- ❑ *Keep ink cartridges out of the reach of children. Do not allow children to drink from or otherwise handle the cartridges.*

- ❑ *Be careful when you handle the used ink cartridges, as there may be some ink around the ink supply port. If ink gets on your skin, wash the area thoroughly with soap and water. If ink gets into your eyes, flush them immediately with water. If discomfort or vision problems remain after a thorough flushing, see a physician immediately.*



Caution:

- ❑ *EPSON recommends the use of genuine EPSON ink cartridges. Other products not manufactured by EPSON may cause damage to your printer not covered by EPSON's warranties.*

- ❑ *Leave the old cartridge installed in the printer until you have obtained a replacement; otherwise, ink remaining in the print head nozzles may dry out.*

- ❑ *Do not refill the ink cartridges. The printer calculates the amount of ink remaining using an IC chip on the ink cartridge. Even if the cartridge is refilled, the amount of ink remaining will not be recalculated by the IC chip and the amount of ink available for use will not change.*

Note:

- ❑ *You cannot continue printing with one ink cartridge empty, even if the other cartridge still contains ink. Before printing, replace the empty cartridge.*



- ❑ *In addition to the ink used during document printing, ink is consumed during the print head cleaning operation, during the self-cleaning cycle which is performed when the printer is turned on, and during ink charging when the ink cartridge is installed in the printer.*







For more information about ink cartridges, see “When handling the ink cartridges” on page 3.

1. Make sure that the printer is on, but not printing. Then, open the printer cover.

Note:

You can identify the status of the printer condition. When the error light is flashing, the black or color ink cartridge is low. When the error light is on, the black or color ink cartridge is empty.

- Press down the  ink cartridge replacement button. The print head moves left to the Ink cartridge replacement position. The  power light begins to flash, and the  error light begins to flash or remains on. To discover which cartridge requires replacing, refer to the table below, or check EPSON Status Monitor 3 (for Windows) or EPSON StatusMonitor (for Macintosh).

| Lights | Action |
|---|---|
|  | Replace the black ink cartridge if the  error light flashes at the same speed as the power light. |
|  | Replace the color ink cartridge if the  error light flashes at twice the speed of the  power light. |
|  | Replace both the black and color ink cartridges if this light remains on. |

● = on, ○ = off, ◌ = flashing



Caution:

Do not move the print head by hand, as this may damage the printer. Always press the  ink cartridge replacement button to move it.

- Lift up the ink cartridge clamp as far as it will go. Take the cartridge out of the printer. If the cartridge is empty, dispose of it properly. Do not take the used cartridge apart or try to refill it.



Warning:

If ink gets on your hands, wash them thoroughly with soap and water. If ink gets into your eyes, flush them immediately with water. If discomfort or vision problems remain after a thorough flushing, see a physician immediately.

4. Remove the new ink cartridge from its protective bag and then only peel off the yellow tape seal. Do not touch the green chip on the side of the cartridge.

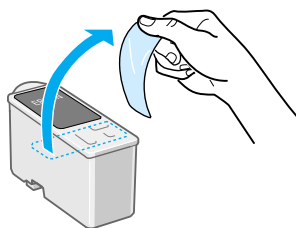

black ink cartridge
Standard Capacity (T007)
Light Capacity (T010)

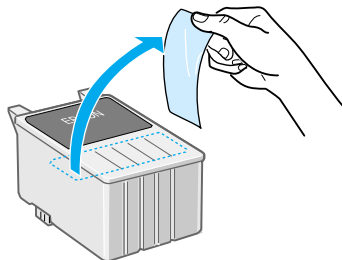

color ink cartridge (T009)



Caution:

- ❑ You must remove the yellow tape seal from the cartridge before installing it; otherwise, the cartridge will become unusable and you will be unable to print.
- ❑ If you have installed an ink cartridge without removing the yellow tape seal, you must remove the cartridge and install a new one. Prepare the new cartridge by removing the yellow tape seal, then install it in the printer.
- ❑ Do not remove the blue portion of the tape seal from the top of the cartridge; otherwise, the print head may become clogged and be unable to print.
- ❑ Do not remove the tape seal from the bottom of the cartridge; otherwise, ink will leak.
- ❑ Do not touch the green IC chip on the side of the cartridge; otherwise, normal operation and printing may not be possible.

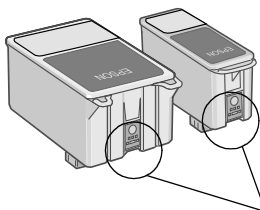

Do not touch this part.



- Align the tabs on the ink cartridge so that they are resting on the tabs protruding from the base of the opened ink cartridge clamp. Push the clamps down until they lock firmly into place.

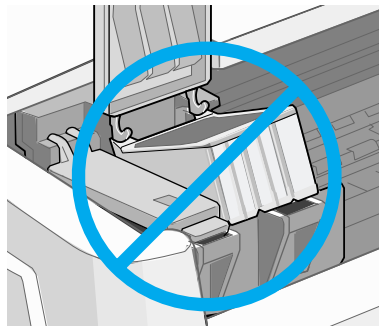

Caution:

- Make sure that the ink cartridge tabs are not under the hinges protruding from the base of the opened ink cartridge clamp, as this could damage the clamp.



- After you remove an ink cartridge from the printer, please insert a new one immediately. If no cartridge is present, the print head may dry out and become unable to print.
- Press the  ink cartridge replacement button. The printer moves the print head and begins charging the ink delivery system. This process takes about one minute to complete. When the ink charging process is finished, the printer returns the print head to its home position, the  power light stops flashing and remains on and the  error light goes out.



Caution:

The  power light continues to flash while the printer is charging ink. Never turn off the printer while this light is flashing. Doing so can result in incomplete charging of ink.

- Close the printer cover.

Troubleshooting

Online problem solving

You can use online problem solving to diagnose and solve most of the problems you may encounter. Refer to the appropriate section below.

For Windows users

The Problem Solver provides you with tips to help solve any problems you may encounter when using your printer. Depending on your location, the Problem Solver may not be accessible. In this case, you can access Technical Support Web Site instead of the Problem Solver.

If you encounter a problem, access the Problem Solver or Technical Support in one of the following ways:

- From the Windows Start menu

Click Start, point to Programs and then to Epson, then click ESP1290 Problem Solver or Technical Support.

- From Status Monitor 3

Click Technical Support in the Status Monitor 3 dialog box.

- From your printer software

Click Technical Support on the Main menu of the printer software.

If you access the Problem Solver and cannot solve your problem, contact Technical Support for assistance by clicking the Technical Support Web Site link in the Problem Solver.

For Macintosh users

EPSON's Technical Support Web Site provides help with problems that cannot be solved using the troubleshooting information in your printer documentation.

To access Technical Support, insert the CD in the CD-ROM drive and open the Install Printer Driver/Utility folder in the EPSON folder, and then double-click the Technical Support Web Site icon.

Error Indicators



You can identify many common printer problems using the lights on your printer's control panel. If the lights are on or flashing, use the following table of panel light patterns to diagnose the problem, then follow the recommended corrective measures.

| Lights | Problem and Solution | |
|--------|---|---|
| ● ◡ ◻ | Paper out | |
| | No paper is loaded in the printer. | Check EPSON Status Monitor 3 or EPSON StatusMonitor. Load paper in the sheet feeder, then press the ◡ ◻ maintenance button. The printer resumes printing and the light goes out. |
| ● ◡ ◻ | Paper jam | |
| | Paper has jammed in the printer. | Check EPSON Status Monitor 3 or EPSON StatusMonitor. Press the ◡ ◻ maintenance button to eject the jammed paper. If the error does not clear, open the printer cover and remove all of the paper inside, including any torn pieces. Then, reload the paper in the sheet feeder and press the ◡ ◻ maintenance button to resume printing. |
| ◡ ◡ ◻ | Ink low | |
| | The black or color ink cartridge is nearly empty. | Obtain a replacement black or color ink cartridge. To determine which cartridge is nearly empty, check the ink level using EPSON Status Monitor 3 or EPSON StatusMonitor. Black: T007 (Standard Capacity) T010 (Light Capacity) Color: T009 |

Maintenance

To keep your printer in good working condition, use the following utilities included in your printer software. To determine which utility to use, locate your problem in the list, then try the solutions recommended for that problem. If you need help accessing the printer software, see “Printing with Windows” on page 22, or “Printing with Macintosh” on page 26. For more details about maintaining your printer, see your online *Reference Guide*.

| Utility | Problem and Solution | |
|---------------------|--|---|
| Nozzle Check | The lines, images, or text in your printout contain gaps or are faint. | <p>Make sure that A4 or Letter size paper is loaded in the sheet feeder.</p> <p>For Windows users, access the printer software and click the Utility tab, then click the Nozzle Check button.</p> <p>For Macintosh users, access the Print or Page Setup dialog box and click the  Utility icon button, then click the Nozzle Check button in the Utility dialog box.</p> <p>Follow the on-screen instructions to check the print head nozzles. If any segments are missing or faint in the printed pattern, the print head nozzles may be clogged.</p> <p>Try using the Head Cleaning utility as described below.</p> |

| Utility | Problem and Solution | |
|------------------------------------|---|---|
| <p>Head Cleaning</p> | <p>The print head nozzle are clogged.</p> | <p>Make sure that the printer is on and the  error light is off.</p> <p>For Windows users, access the printer software and click the Utility tab, then click the Head Cleaning button.</p> <p>For Macintosh users, access the printer software and click the  Utility icon button, then click the Head Cleaning button.</p> <p>Follow the on-screen instructions to clean the print head.</p> |
| <p>Print Head Alignment</p> | <p>The vertical lines in your printout are not aligned correctly.</p> | <p>Make sure that A4 or Letter size plain paper is loaded in the sheet feeder.</p> <p>For Windows users, access the printer software and click the Utility tab, then click the Print Head Alignment button.</p> <p>For Macintosh users, access the printer software and click the  Utility icon button, then click the Print Head Alignment button.</p> <p>Follow the on-screen instructions to align the print head.</p> |

Correcting USB Problems

If you are having difficulty using your printer with a USB connection, see if your problem is listed below, then follow the instructions given to resolve the problem.

Printer does not work correctly with the USB cable

If your printer does not work correctly with the USB cable, try one or both of these solutions:

- ❑ Use the USB cable (C83623*) recommended in “System Requirements” on page 67.
- ❑ For best results, you should connect the printer directly to the computer’s USB port. If you must use multiple USB hubs, we recommend that you connect the printer to the first tier hub.

Operating System

Your computer must be a Windows 98 or Windows 2000 pre-installed model. You may not be able to install or run the USB Printer Driver on a computer which is not equipped with a USB port or which has been upgraded from Windows 95 to Windows 98 or 2000. For Windows Me users, your computer must be a Windows Me pre-install model or upgraded from Windows 98 pre-installed model.

For details about your computer, contact your dealer.

Printer software installation

Please take notice about the following.

- ❑ When using Windows 2000, you must follow the steps in the Setup Guide to install the printer software; otherwise, Microsoft's Universal driver may be installed instead. To check if the Universal driver has been installed, open the Printers folder and right-click the icon for your printer. To open the printer driver, click Printing Preferences on the shortcut menu that appears, then right-click anywhere in the driver. If About is displayed in the shortcut menu that appears, click it. A message box with the words "Unidrv Printer Driver" appears. You must reinstall the printer software as described in the Setup Guide. If ABOUT is not displayed, the printer software has been installed correctly.
- ❑ If the Digital Signature Not Found dialog box appears during the installation process, click Yes. If you click NO, you will must follow the steps in the Setup Guide to install the printer software again.

USB driver installation

For Windows Me, 98 and 2000 users, follow the directions below to ensure that the USB driver is installed correctly.

Note:

The illustrations used in this section show the procedure for Windows 98.

1. Click the Start button, point to Settings, and click Printers. Make sure that the icon for your printer appears in the Printers window.

Select the icon for your printer, then click Properties on the File menu.



2. For Windows 98 users, click the Details tab and make sure that EPUSBX: (EPSON Stylus Photo 1290) is displayed in the Print to the following port list box. For Windows 2000 users, click the Ports tab and make sure that USBxxx, EPSON Stylus Photo 1290 is displayed in the Print to the following port(s) list box.

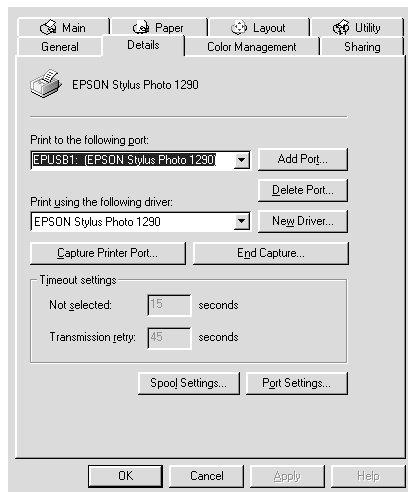

Note:

If the correct port is not displayed, refer to the next section, “Make sure that EPSON USB Printer Devices appears on the Device Manager menu (for Windows Me and 98)”.

The Device Manager menu (for Windows Me and 98 only)

If you canceled the plug-and-play driver installation before the procedure was complete, either the USB printer device driver or the printer software may be incorrectly installed.

Follow the steps below to check the installation and reinstall the drivers.

1. Turn the printer on. Plug the USB cable into the printer and the computer.

2. Right-click the My Computer icon on your desktop, then click Properties.
3. Click the Device Manager tab.

If your drivers are correctly installed, EPSON USB Printer Devices should appear on the Device Manager menu.

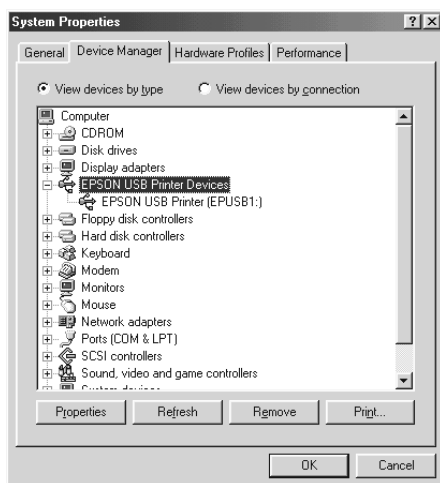

If EPSON USB Printer Devices does not appear on the Device Manager menu, click the plus (+) sign beside Other devices to view the installed devices.



If USB Printer appears under Other devices, the USB printer device driver is not installed correctly. If EPSON Stylus Photo 1290 appears, the printer software is not installed correctly.

If neither USB Printer nor EPSON Stylus Photo 1290 appears under Other devices, click Refresh or unplug the USB cable from the printer, then plug it into the printer again.

4. Under Other devices, select USB Printer or EPSON Stylus Photo 1290 and click Remove. Then, click OK.

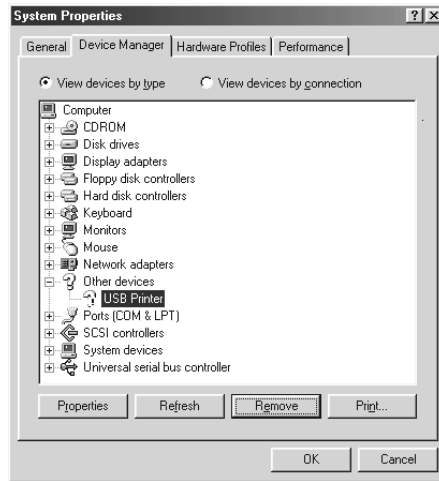

5. When the following dialog box appears, click OK. Then click OK to close the System Properties dialog box.

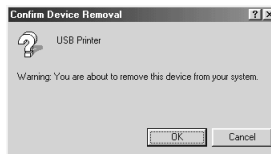

6. Turn off the printer and restart your PC. Then, reinstall the drivers from the beginning, following the instructions in the *Setup Guide*.

Note:

If the problem does not clear, contact your dealer.

Reinstall the USB printer device driver and printer software (Windows Me and 98 only)

If the solutions above do not correct the problem, try reinstalling the USB printer device driver and the printer software. First, uninstall EPSON Printer Software using the Add/Remove Programs utility in the Control Panel, then uninstall EPSON USB Printer Devices. Next, reinstall the software as described in *Setup Guide*. If EPSON USB Printer Devices is not registered in the Add/Remove Programs list, access the CD-ROM and double-click `epusbun.exe` in Win9x folder. Then follow the on-screen instructions.

Options and Consumable Products

Options

The following options are available for your printer.

Interface cables

EPSON supplies the following interface cables for your printer. However, you can use any interface cables that meet these specifications. See your computer manual for any additional requirements.

- ❑ Parallel Interface Cable (shielded) C83602* from D-SUB 25-pin (computer) to 36-pin Amphenol 57 Series (printer)
- ❑ USB Interface Cable (shielded) C83623* from Series A 4-pin (computer) to series B 4-pin (printer).

Note:

- ❑ *The asterisk (*) is a substitute for the last digit of the product number, which varies by location.*
- ❑ *Depending on your geographic location, this cable may not be supplied.*



Caution:

Use only interface cables which meet the specifications listed above. Using other cables not covered by EPSON warranties may cause the printer to malfunction.

Consumable products

The following ink cartridges and EPSON special media are available for your printer.

Ink cartridges

You can use the following cartridges with your printer.

| Type of ink | Product numbers of ink |
|---------------------|---|
| Black ink cartridge | Standard Capacity: T007 Light Capacity: T010 |
| Color ink cartridge | T009 |

Note:

The product numbers of ink cartridges may vary by location.

Media types

EPSON offers specially-designed media for ink jet printers to meet most high-quality printing needs.

To make the Media Type setting in your printer software, select the Media Type setting that matches the media that is loaded in the printer. To find out what media type you are using, find your media in the list below and refer to the corresponding media type under which it is grouped (shown in larger type). For some media, there are several Media Type settings to choose from.

The available media types are listed below.

Note:

For the latest information on available media, visit our regional customer service web site. See "Contacting Customer Support" on page 54 for details.

Plain Paper

Plain paper

Envelopes

EPSON Premium Ink Jet Plain Paper (A4) S041214

EPSON Bright White Ink Jet Paper (A4) S041442

360 dpi Ink Jet Paper

EPSON 360 dpi Ink Jet Paper (A4) S041059
S041025

EPSON 360 dpi Ink Jet Paper (Letter) S041060
S041028

EPSON 360 dpi Ink Jet Paper (A3) S041065
S041046

EPSON 360 dpi Ink Jet Paper (Super A3/Super B) S041066
S041047

EPSON Iron-On Cool Peel Transfer Paper (A4) S041154

EPSON Iron-On Cool Peel Transfer Paper (Letter) S041153
S041155

EPSON Iron-On Cool Peel Transfer Paper (A3) S041238

Photo Quality Ink Jet Paper

| | |
|--|--------------------|
| EPSON Photo Quality Ink Jet Paper (A4) | S041061 S041026 |
| EPSON Photo Quality Ink Jet Paper (Letter) | S041062 S041029 |
| EPSON Photo Quality Ink Jet Paper (Legal) | S041067 S041048 |
| EPSON Photo Quality Ink Jet Paper (A3) | S041068 S041045 |
| EPSON Photo Quality Ink Jet Paper (Super A3/Super B) | S041069 S041043 |
| EPSON Photo Quality Ink Jet Paper (B) | S041070 S041044 |
| EPSON Photo Quality Ink Jet Cards (A6) | S041054 |
| EPSON Photo Quality Ink Jet Cards (5 × 8") | S041121 |
| EPSON Photo Quality Ink Jet Cards (8 × 10") | S041122 |
| EPSON Photo Quality Self Adhesive Sheets (A4) | S041106 |
| EPSON Ink Jet Note Cards A6 (with envelopes) | S041147 |
| EPSON Ink Jet Greeting Cards 5 × 8" (with envelopes) | S041148 |
| EPSON Ink Jet Greeting Cards 8 × 10" (with envelopes) | S041149 |

Matte Paper-Heavyweight

| | |
|---|-------------------------------|
| EPSON Matte Paper-Heavyweight (A4) | S041256 S041258 S041259 |
| EPSON Matte Paper-Heavyweight (Letter) | S041257 |
| EPSON Matte Paper-Heavyweight (B) | S041266 |
| EPSON Matte Paper-Heavyweight (A3) | S041260 S041261 S041262 |
| EPSON Matte Paper-Heavyweight (Super A3/Super B) | S041263 S041264 S041265 |

Photo Paper

| | |
|--|---------|
| EPSON Photo Paper (A4) | S041140 |
| EPSON Photo Paper (Letter) | S041141 |
| EPSON Photo Paper (A3) | S041142 |
| EPSON Photo Paper (Super A3/Super B) | S041143 |
| EPSON Photo Paper (B) | S041156 |
| EPSON Photo Paper (4 × 6") | S041134 |
| EPSON Photo Paper (4 × 6" No Perforations) | S041458 |
| EPSON Photo Paper (100 × 150 mm) | S041255 |
| EPSON Photo Paper (200 × 300 mm) | S041254 |
| EPSON Photo Paper (89 mm × 7 M) | S041281 |
| EPSON Photo Paper (100 mm × 8 M) | S041279 |
| EPSON Photo Paper (210 mm × 10 M) | S041280 |
| EPSON Photo Paper (329 mm × 10 M) | S041233 |
| EPSON Panoramic Photo Paper (210 × 594 mm) | S041145 |
| EPSON Photo Paper Cards (A4) | S041177 |

Photo Quality Glossy Film

| | |
|---|---------|
| EPSON Photo Quality Glossy Film (A6) | S041107 |
| EPSON Photo Quality Glossy Film (A4) | S041071 |
| EPSON Photo Quality Glossy Film (Letter) | S041072 |
| EPSON Photo Quality Glossy Film (A3) | S041073 |
| EPSON Photo Quality Glossy Film (Super A3/Super B) | S041074 |
| EPSON Photo Quality Glossy Film (B) | S041075 |
| EPSON Photo Stickers 16 (A6) | S041144 |
| EPSON Photo Stickers 4 (A6) | S041176 |

Ink Jet Transparencies

| | |
|---------------------------------------|---------|
| EPSON Ink Jet Transparencies (A4) | S041063 |
| EPSON Ink Jet Transparencies (Letter) | S041064 |

Premium Glossy Photo Paper

| | |
|--|--------------------|
| EPSON Premium Glossy Photo Paper (A4) | S041287 S041297 |
| EPSON Premium Glossy Photo Paper (Letter) | S041286 |
| EPSON Premium Glossy Photo Paper (A3) | S041288 |
| EPSON Premium Glossy Photo Paper (B) | S041290 |
| EPSON Premium Glossy Photo Paper (Super A3/Super B) | S041289 |
| EPSON Premium Glossy Photo Paper (100 mm × 8 M) | S041302 S041303 |
| EPSON Premium Glossy Photo Paper (210 mm × 10 M) | S041376 S041377 |

| | |
|---|--------------------|
| EPSON Premium Glossy Photo Paper (329 mm × 7 M) | S041378 S041379 |
| EPSON Premium Glossy Photo Paper (5 × 7") | S041464 |
| EPSON Premium Glossy Photo Paper (8 × 10") | S041465 |
| EPSON Premium Glossy Photo Paper (11 × 14") | S041466 |
| | |
| EPSON Premium Semigloss Photo Paper (A4) | S041332 |
| EPSON Premium Semigloss Photo Paper (Letter) | S041331 |
| EPSON Premium Semigloss Photo Paper (A3) | S041334 |
| EPSON Premium Semigloss Photo Paper (SuperA3/SuperB) | S041327 S041328 |
| EPSON Premium Semigloss Photo Paper (100 mm × 8 M) | S041329 S041330 |
| EPSON Premium Semigloss Photo Paper (210 mm × 8 M) | S041336 |
| EPSON Premium Semigloss Photo Paper (329 mm × 10 M) | S041338 |

Ink Jet Back Light Film

| | |
|------------------------------------|---------|
| EPSON Ink Jet Back Light Film (A3) | S041131 |
|------------------------------------|---------|

ColorLife Photo Paper

| | |
|--|--------------------|
| EPSON ColorLife Photo Paper (A4) | S041560 |
| EPSON ColorLife Photo Paper (Letter) | S041500 |
| EPSON ColorLife Photo Paper (Super A3/Super B) | S041561 S041501 |

Note:

The availability of special media varies by location.

Customer Support

Technical Support Web Site

EPSON's Technical Support Web Site provides help with problems that cannot be solved using the troubleshooting information in your printer documentation. If you have a Web browser and can connect to the Internet, access that site at:

<http://support.epson.net/StylusPhoto1290>

Contacting Customer Support

If your EPSON product is not operating properly and you cannot solve the problem using the troubleshooting information in your product documentation, contact customer support services for assistance. If customer support for your area is not listed below, contact the dealer where you purchased your product.

Customer support will be able to help you much more quickly if you give them the following information:

- Product serial number
(The serial number label is usually on the back of the product.)
 - Product model
 - Product software version
(Click About, Version Info, or similar button in the product software.)
 - Brand and model of your computer
 - Your computer operating system name and version
 - Names and versions of the software applications you normally use with your product
-

For users in the Middle East

Some of these services may be available in English only.

<http://www.epson.com>

Select your country from our Internet home page for a full list of support and warranty services including:

- Register your product on-line
- Free access to the latest EPSON software drivers
- Easy access to frequently asked questions
- Interactive web based support tool to help you quickly resolve support issues
- Chat directly with a support technician on-line
- Email Technical Support

Technical Support Via Email and Telephone

Email: epson_support@compubase.co.ae

Telephone: +971 4 351 7777

Fax: +971 4 351 6617

Pre-Sales Enquiries, Literature Requests and Nearest Dealer

Select your country from our Internet home page at
<http://www.epson.com>.

For users in Scandinavia

Some of these services may be available in English only.

<http://www.epson.com>

Select your country from our Internet home page for a full list of support and warranty services including:

- Register your product on-line
- Free access to the latest EPSON software drivers
- Easy access to frequently asked questions
- Interactive web based support tool to help you quickly resolve support issues
- Chat directly with a support technician on-line
- Email Technical Support

Support Via Telephone

| | |
|---------|--------------|
| Denmark | 80 88 11 27 |
| Finland | 0800 523 010 |
| Norway | 800 11 828 |
| Sweden | 08 445 12 58 |

Pre-Sales Enquiries Literature Requests and Nearest Dealer

| | | |
|---------|------------|---|
| Denmark | Home Page: | http://www.epson.dk |
| | Telephone: | 38 48 71 37 |
| Finland | Home Page: | http://www.epson.fi |
| | Telephone: | 0981 710 083 |
| Norway | Home Page: | http://www.epson.no |
| | Telephone: | 231 62 124 |
| Sweden | Home Page: | http://www.epson.se |
| | Telephone: | 08 519 92 082 |

For users in South Africa

Some of these services may be available in English only.

<http://www.epson.co.za>

Visit our Internet home page for a full list of support and warranty services including:

- Register your product on-line
- Free access to the latest EPSON software drivers
- Easy access to frequently asked questions
- Interactive web based support tool to help you quickly resolve support issues
- Chat directly with a support technician on-line
- Email Technical Support

Support Via Telephone

Telephone: (011) 444-5223 or 0800 600 578

Pre-Sales Enquiries Literature Requests and Nearest Dealer

Home Page: <http://www.epson.co.za>

Telephone: (011) 448-2736 or 0800 005 956

For users in Australia

EPSON Australia wishes to provide you with a high level of customer service. In addition to your product documentation, we provide the following sources for obtaining information:

Your Dealer

Don't forget that your dealer can often help identify and resolve problems. The dealer should always be the first call for advise on problems; they can often solve problems quickly and easily as well as give advise on the next step to take.

Internet URL <http://www.epson.com.au>

Access the EPSON Australia World Wide Web pages. Worth taking your modem here for the occasional surf! The site provides a download area for drivers, EPSON contact points, new product information and technical support (e-mail).

EPSON Faxback Service

EPSON Faxback service will fax you the latest specifications for most EPSON products offered in Australia. Phone (02) 9903 9075 and the system will guide you through a number of choices before faxing the information to your fax machine.

EPSON Helpdesk

EPSON Helpdesk is provided as a final backup to make sure our clients have access to advise. Operators on the Helpdesk can aid you in installing, configuring and operating your EPSON product. Our Pre-sales Helpdesk staff can provide literature on new EPSON products and advise where the nearest dealer or service agent is located. Many types of queries are answered here.

The Helpdesk numbers are:

Phone: 1300 361 054

Fax: (02) 9903 9189

We encourage you to have all the relevant information on hand when you ring. The more information you prepare, the faster we can help solve the problem. This information includes your EPSON product documentation, type of computer, operating system, application programs, and any information you feel is required.

For users in Singapore

Sources of information, support, and services available from Epson Singapore are:

World Wide Web (<http://www.epson.com.sg>)

Information on product specifications, drivers for download, Frequently Asked Questions (FAQ), Sales Enquiries, and Technical Support via e-mail are available.

Epson HelpDesk (Phone: (65) 6586 3111)

Our HelpDesk team can help you with the following over the phone:

- Sales enquiries and product information
- Product usage questions or problem
- Enquiries on repair service and warranty

For users in Thailand

Contact for information, support, and services are:

World Wide Web (<http://www.epson.co.th>)

Information on product specifications, drivers for download, Frequently Asked Questions (FAQ), and e-mail are available.

Epson Hotline (Phone: (66)2-670-0333)

Our Hotline team can help you with the following over the phone:

- Sales enquiries and product information
- Product usage questions or problem
- Enquiries on repair service and warranty

For users in Indonesia

Contacts for information, support, and services are:

World Wide Web (<http://www.epson.co.id>)

- Information on product specifications, drivers for download
- Frequently Asked Questions (FAQ), Sales Enquiries, questions through e-mail

Epson Hotline

- Sales enquiries and product information
- Technical support

Phone (62) 21-572 4350

Fax (62) 21-572 4357

EPSON Support Center

| | |
|------------|---|
| Jakarta | Wisma Bisnis Indonesia 3rd floor Jl. Letjen S.Parman Kav. 12, Slipi-Jakarta Phone/Fax: (62) 21-5357159 |
| Bandung | Lippo Center 8th floor Jl. Gatot Subroto No.2 Bandung Phone/Fax: (62) 22-7303766 |
| Surabaya | Gedung Koko Perdana 3rd floor Jl. Jend. Basuki RakhmatNo. 105-107 Surabaya Phone/Fax: (62) 31-5458562 |
| Yogyakarta | Hotel Natour Garuda Jl. Malioboro No. 60 Yogyakarta Phone: (62) 274-566353/22-143 |

For users in Hong Kong

To obtain technical support as well as other after-sales services, users are welcome to contact EPSON Hong Kong Limited.

Internet Home Page

EPSON Hong Kong has established a local home page in both Chinese and English on the Internet to provide users with the following information:

- Product information
- Answers to Frequently Asked Questions (FAQs)

- ❑ Latest versions of EPSON product drivers

Users can access our World Wide Web home page at:

<http://www.epson.com.hk>

Electronic Bulletin Board System

An electronic bulletin board system (BBS) is also available to obtain product information and the latest versions of product drivers. You can log on to the following number for the BBS service:

BBS: (852) 2827-4244

Technical Support Hotline

You can also contact our technical staff at the following telephone and fax numbers:

Phone: (852) 2585-4399

Fax: (852) 2827-4383

For users in Malaysia

Contacts for information, support, and services are:

World Wide Web (<http://www.epson.com.my>)

- ❑ Information on product specifications, drivers for download
- ❑ Frequently Asked Questions (FAQ), Sales Enquiries, questions through e-mail

Epson Trading (M) SDN. BHD

Head Office.

Phone: 603-56288288

Fax: 603-56212088

Epson Helpdesk

- ❑ Sales enquiries and product information (Infoline)

Phone: 603-56288222

- ❑ Enquiries on repair services & warranty, product usage and technical support (Techline)

Phone: 603-56288333

For users in India

Contacts for information, support, and services are:

World Wide Web (<http://www.epson.co.in>)

Information on product specifications, drivers for download, Frequently Asked Questions (FAQ), Products Enquiry, and Technical Query are available.

Epson India Head Office - Bangalore:

Phone: 5321 266-70

Fax: 5581799/5321095

Epson India Regional Offices:

| | |
|-----------|--|
| Mumbai | Phone: 8261516-17 Fax: 8257287 |
| Delhi | Phone: 6447201-06 Fax: 6447205 |
| Chennai | Phone: 8203940/41 Fax: 8272463 |
| Kolkata | Phone: 2871355/56 Fax: 2871357 |
| Hyderabad | Phone: 6329335/36 |
| Cochin | Phone: 361638/362677 Fax: 352940 |
| Pune | Phone: 4335460-ext 214 Fax: 4330881 |
| Ahmedabad | Phone: 6407176/77 |

Help Desk

Nine City Help Line -9622 037766, available at Vadadora, Bangalore, Chennai, Hyderabad, Cochin, Mumbai, Pune, Delhi and Kolkata.

For users in the Philippines

To obtain technical support as well as other after sales services, users are welcome to contact the EPSON Philippines Corporation at the telephone and fax numbers and e-mail address below:

Phone: (63) 2-813-6567

Fax: (63) 2-813-6545

E-mail: customersupport@epc.epson.com.ph

World Wide Web (<http://www.epson.com.ph>)

Information on product specifications, drivers for download, Frequently Asked Questions (FAQ), and E-mail Enquiries are available.

Epson Helpdesk (Phone: (63) 2-813-6567)

Our Hotline team can help you with the following over the phone:

- Sales enquiries and product information
- Product usage questions or problems
- Enquiries on repair service and warranty

System Requirements

Using the online Reference Guide

Refer to the appropriate section below for the minimum system requirements necessary to use the online *Reference Guide*.

For Windows computers

| | |
|-----------------|--|
| System | Microsoft Windows® Millennium Edition, 98, 95, 2000, or NT® 4.0 |
| CPU | Pentium 150MHz processor (for Windows Me) i486/66 MHz (for Windows 98) (Pentium or better recommended) i486/25 MHz (for Windows 95 and NT 4.0) (Pentium or better recommended) Pentium 133 MHz for Windows 2000 |
| Memory | 16 MB RAM for Windows 98, 95, and NT 4.0 (32 MB RAM or more recommended) 32 MB RAM for Windows Me and 2000 |
| Hard disk space | 5 MB to install the Reference Guide |
| CD-ROM drive | Double-speed (quad-speed or faster recommended) |
| Display | 640 × 480 pixel or 800 × 600 pixel resolution, with High Color (16 bit) or True Color (32 bit) setting |
| Browser | Web browser (Microsoft Internet Explorer 4.0 or later recommended) |

For Macintosh computers

| | |
|-----------------|--|
| System | Mac OS 8.1/8.5.1/8.6/9.X |
| Memory | 16 MB RAM (32 MB RAM or more recommended) |
| Hard disk space | 5 MB to install the Reference Guide |
| CD-ROM drive | Double-speed (quad-speed or faster recommended) |
| Display | 640 × 480 pixel or 800 × 600 pixel resolution, with High Color (16 bit) or True Color (32 bit) setting |
| Browser | Web browser (Microsoft Internet Explorer 4.0 or later recommended) |

EPSON OVERSEAS MARKETING LOCATIONS

EPSON AMERICA, INC.

3840 Kilroy Airport Way
Long Beach, CA 90806
Phone: (562) 981-3840
Fax: (562) 290-5220

EPSON UK LTD.

Campus 100, Maylands Avenue,
Hemel Hempstead, Herts,
HP2 7TJ, U.K.
Phone: (+44) 01442 261144
Fax: (+44) 01442 227227

EPSON DEUTSCHLAND GmbH

Zülpicher Straße 6,
40549 Düsseldorf Germany
Phone: (0211) 56030
Fax: (0211) 5047787

EPSON FRANCE S.A.

68 bis, rue Marjolin
92300, Levallois-Perret, France
Phone: 33.1.41.86.26.56
Telex: 610657

EPSON AUSTRALIA PTY. LTD.

70 GIBBES STREET,
CHATSWOOD 2067 NSW.
Phone: 2-9903-9000
Fax: 2-9903-9177

EPSON SINGAPORE PTE. LTD.

No. 1 Temasek Avenue #36-00
Millenia Tower, Singapore 039192
Phone: (065) 633 77 911
Fax: (065) 633 41 185

EPSON HONG KONG LTD.

Rooms 4706-10, 47/F,
China Resources Bldg.,
26 Harbour Road, Wanchai, Hong Kong
Phone: 2585-4300
Fax: 2827-7083

EPSON TAIWAN TECHNOLOGY & TRADING LTD.

10F, No. 287 Nanking E. Road, Sec. 3,
Taipei, Taiwan,
Phone: (02) 2717-7360
Fax: (02) 2712-9164

EPSON ITALIA S.p.A.

V.le F.lli Casiraghi 427
20099 Sesto S.Giovanni
MI, Italy
Phone: +3902262331
Fax: +39022440750

EPSON IBERICA S.A.

Av. de Roma, 18-26
08290 Cerdanyola del Valles
Barcelona, Spain
Phone: 582. 15.00
Fax: 582. 15.55

**SEIKO EPSON CORPORATION
(Hirooka Office)**

80 Harashinden, Hirooka
Shiojiri-shi, Nagano-ken
399-0785 Japan

EPSON PORTUGAL, S.A.

R. do Progresso, 471, 1° Perafita
4460 Matosinhos, Portugal
Phone: (02) 996 14 02
Fax: (02) 996 14 11

EPSON

Color Ink Jet Printer

EPSON STYLUS™ PHOTO 1290

Daily Use

Printed in XXXX
02.XX-XX